

PLAN

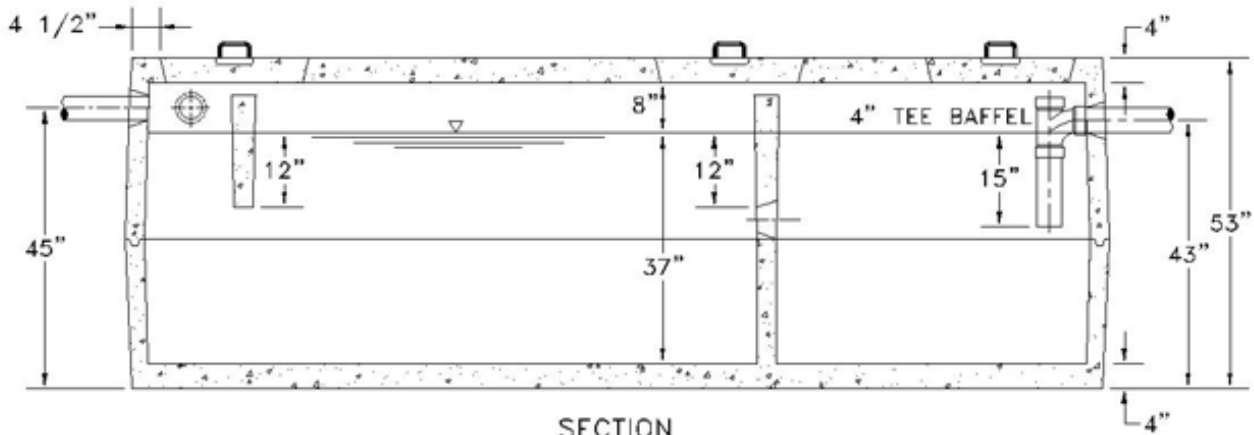

SECTION

1500 GALLON 2 COMPARTMENT SEPTIC TANK